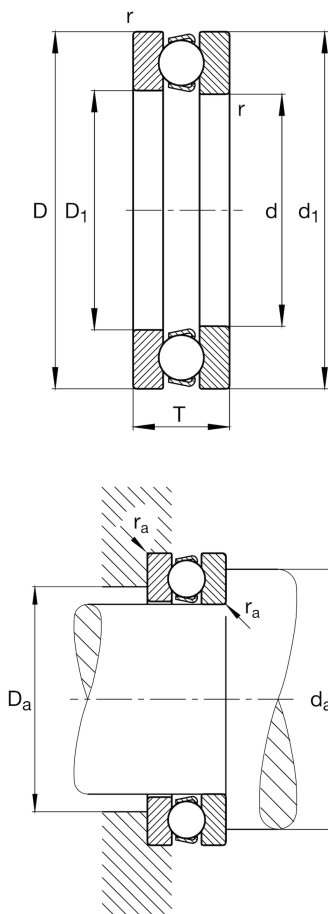
**FAG****51314**

Axial deep groove ball bearing

Schaeffler ID:
0167153650000Axial deep groove ball bearing 513, single
direction, steel sheet metal cage

Technical information

**Dimensions**

r_{\min}	1,1 mm	Minimum chamfer dimension
D_1	72 mm	Inner diameter housing washer
d_1	125 mm	Outer diameter shaft washer
	1,977 kg	Weight

Main Dimensions & Performance Data

d	70 mm	Inner diameter shaft washer
D	125 mm	Outer diameter housing washer
T	40 mm	Height
C_a	134.000 N	Basic dynamic load rating, axial
C_{0a}	290.000 N	Basic static load rating, axial
C_{ua}	13.300 N	Fatigue load limit, axial
n_G	2.750 1/min	Limiting speed
$n_{\vartheta r}$	4.950 1/min	Reference speed

Mounting dimensions

$d_{a \min}$	103 mm	Minimum diameter shaft shoulder
$D_{a \max}$	92 mm	Maximum diameter of housing shoulder
$r_{a \max}$	1 mm	Maximum filled radius

Calculation factors

A	0,51	Minimum load factor
-----	------	---------------------

Temperature range

T_{\min}	-30 °C	Operating temperature min.
T_{\max}	150 °C	Operating temperature max.