

FAG

★ 51208

Axial deep groove ball bearing

Schaeffler ID:
0167150550000Axial deep groove ball bearing 512, single
direction, steel sheet metal cage

★ Preferred product

Technical information

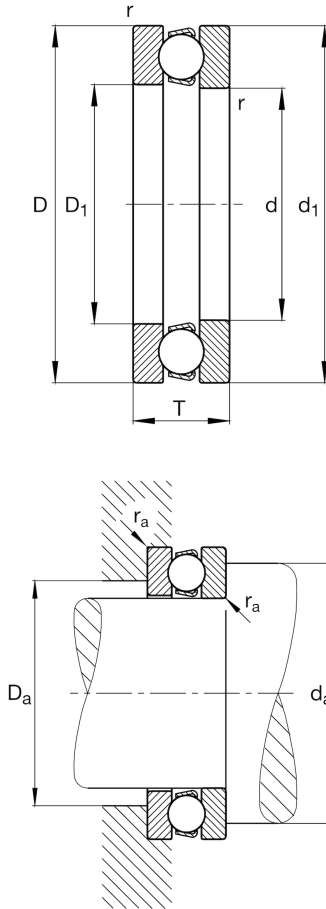

Temperature range

T_{\min}	-30 °C	Operating temperature min.
T_{\max}	150 °C	Operating temperature max.
	0,268 kg	Weight

Main Dimensions & Performance Data

d	40 mm	Bore diameter
D	68 mm	Outside diameter
T	19 mm	Height
C_a	44.000 N	Basic dynamic load rating, axial
C_{0a}	97.000 N	Basic static load rating, axial
C_{ua}	4.400 N	Fatigue load limit, axial
n_G	5.500 1/min	Limiting speed
n_{gr}	6.900 1/min	Reference speed

Dimensions

r_{\min}	1 mm	Minimum chamfer dimension
D_1	42 mm	Bore diameter housing washer
d_1	68 mm	Lip diameter shaft washer

Mounting dimensions

$d_{a \min}$	57 mm	Minimum diameter shaft shoulder
$D_{a \max}$	51 mm	Maximum diameter of housing shoulder
$r_{a \max}$	1 mm	Maximum recess radius

Additional information

A	0,05	Minimum load factor
---	------	---------------------