



FAG

★ 30304-A

Tapered roller bearing

Schaeffler ID:
0167108430000Tapered roller bearings 303, main
dimensions to DIN ISO 355 / DIN 720,
separable, adjusted or in pairs

★ Preferred product

Technical information

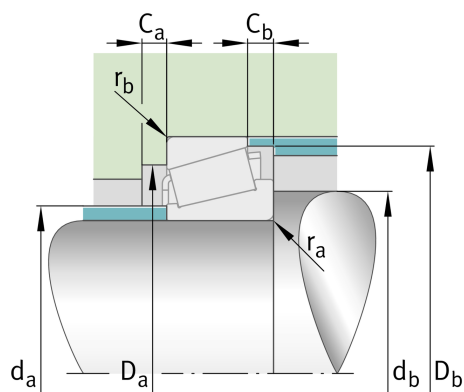
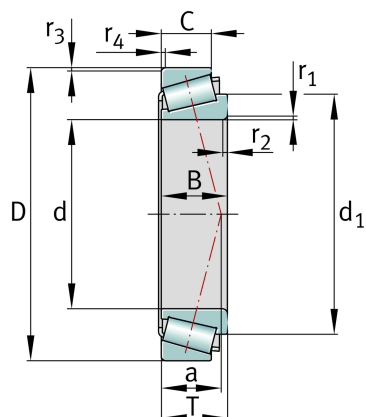

Main Dimensions & Performance Data

d	20 mm	Bore diameter
D	52 mm	Outside diameter
B	15 mm	Width, inner ring
C	13 mm	Width, outer ring
T	16,25 mm	Width, total
C_r	34.000 N	Basic dynamic load rating, radial
C_{0r}	32.500 N	Basic static load rating, radial
C_{ur}	3.700 N	Fatigue load limit, radial
n_G	15.600 1/min	Limiting speed
n_{gr}	9.700 1/min	Thermal speed rating
	0,168 kg	Weight

Dimensions

	T2FB020	Comparative designation to ISO 10317 and ISO 355
$r_{1,2 \text{ min}}$	1,5 mm	Minimum chamfer dimension of inner ring back face
$r_{3,4 \text{ min}}$	1,5 mm	Minimum chamfer dimension of outer ring back face
a	12 mm	Distance between the apexes of the pressure cones
d_1	36,1 mm	Guidance rib diameter of inner ring

Mounting dimensions

$d_{a \max}$	28 mm	Maximum diameter of shaft shoulder
$d_{b \min}$	27 mm	Minimum diameter of shaft shoulder
$D_{a \min}$	44 mm	Minimum diameter of housing shoulder
$D_{a \max}$	45 mm	Maximum diameter of housing shoulder
$D_{b \min}$	47 mm	Minimum diameter of housing shoulder
$C_{a \min}$	2 mm	Minimum axial space
$C_{b \min}$	3 mm	Minimum axial space
$r_{a \max}$	1,5 mm	Maximum fillet radius of shaft
$r_{b \max}$	1,5 mm	Maximum fillet radius of housing

Calculation factors

e	0,3	Limiting value of F_a/F_r for the applicability of diff. Values of factors X and Y
Y	2	Dynamic axial load factor
Y_0	1,1	Static axial load factor

Temperature range

T_{\min}	-30 °C	Operating temperature min.
T_{\max}	120 °C	Operating temperature max.